

Datasheet

Touch for Nano Anthracite

Part No: 100181

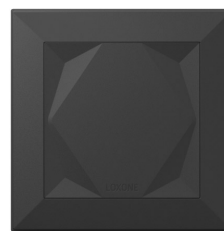

About the product

The Loxone Touch for Nano is a **module** that can be plugged into the Loxone Nano IO Air or the Nano Dimmer Air. It has **five touch points** for operating the most important functions in a room. When a button is touched, a click is heard as **acoustic confirmation**.

Electrical Specifications

Power Supply	via Nano IO Air / Nano Dimmer Air
Temperature	-20 ... 70°C / -4 ... 158°F
Recommended mounting height	135cm / 53.15"
Touch points	5 touch points, capacitive touch detection
Click feedback	Yes

Ambient Conditions

Humidity	max. 95% r.H. (non condensing)
----------	--------------------------------

Connection Diagram

Connection Diagram

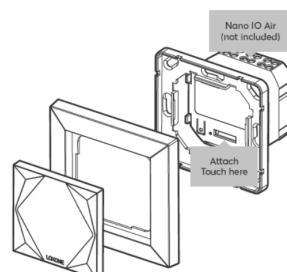
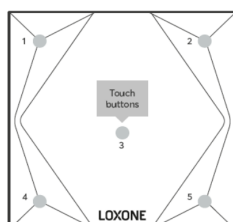

Product Characteristics

Colours	Anthracite: RAL 7016
Finish	Matte

Weight & Dimensions

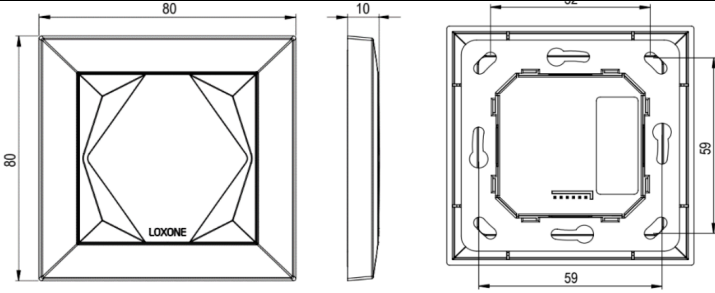
Net weight	50g
Total weight	70 g
Product dimensions	80x80x10mm / 3.15x3.15x0.4" (LxWxH)
Product dimensions drawing	 <p>The drawing consists of three views: a front view showing a square frame with a central diamond-shaped cutout and a depth of 10mm; a side view showing the profile of the frame; and a top view showing the internal components and mounting points, with dimensions of 80mm width and 80mm height, and a central cutout of 59mm width.</p>
Pack size	98x90x33mm / 3.86x3.54x1.30" (LxWxH)

Certifications & Standards

Safety class	IP40
Standards	UL 62368-1:2019 Ed.3+R:22Oct2021 CSA C22.2#62368-1:2019 Ed.3+U1 IEC 62368-1:2018
Certifications	 <p>The certifications shown are CE, UKCA, ETL Intertek, and CB.</p>

Installation must be carried out by a qualified electrician in accordance with the relevant regulations.

Published by

Loxone Electronics GmbH
Smart Home 1
4154 Kollerschlag
Austria
Tel: +43 7287 7070-0
loxone.com

Loxone UK Ltd.
The Forum
Station Road
Theale, RG7 4RA
United Kingdom

Datenblatt

Touch for Nano Anthrazit

Part No: 100181

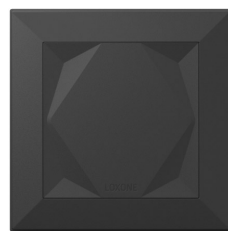

Über das Produkt

Der Loxone Touch for Nano ist ein **Modul zum Aufstecken** auf die Loxone Nano IO Air oder den Nano Dimmer Air. Er verfügt über **fünf Tastpunkte** zur Bedienung der wichtigsten Funktionen eines Raumes. Bei Berührung einer Taste erfolgt ein Klicken als **akustische Bestätigung**.

Elektrische Spezifikationen

Spannungsversorgung	via Nano IO Air / Nano Dimmer Air
Temperatur	-20 ... 70°C / -4 ... 158°F
Empfohlene Montagehöhe	135cm / 53,15"
Tastpunkte	5 Tastpunkte, kapazitive Berührungserkennung
Klick Feedback	Ja

Umgebungsbedingungen

Luftfeuchtigkeit	max. 95% r.H. (nicht kondensierend)
------------------	-------------------------------------

Anschlussplan

Anschlussplan

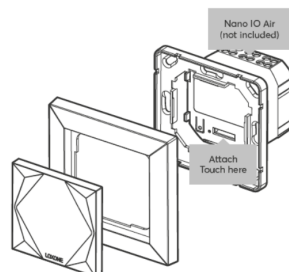
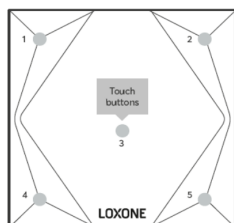

Produkteigenschaften

Farbe	Anthracite: RAL 7016
Glanzgrad	Matt

Gewicht & Abmessungen

Nettogewicht	50g
Bruttogewicht	70 g
Produktmaße	80x80x10mm / 3,15x3,15x0,4" (LxBxH)
Produktmaßzeichnung	<p>The technical drawing consists of three views: a front view showing a square frame with a central diamond-shaped cutout and a depth of 10mm; a side view showing the profile of the frame; and a top view showing the internal layout of the device with dimensions 80mm by 80mm and a central cutout of 59mm by 59mm.</p>
Packmaß	98x90x33mm / 3,86x3,54x1,30" (LxBxH)

Zertifizierungen & Standards

Schutzklasse	IP40
Normen	UL 62368-1:2019 Ed.3+R:22Oct2021 CSA C22.2#62368-1:2019 Ed.3+U1 IEC 62368-1:2018
Zertifizierungen	<p>The certification logos shown are CE, UKCA, ETL Intertek (with 'c' and 'us' markings), and CB.</p>

Die Installation muss von einer qualifizierten Elektrofachkraft gemäß den einschlägigen Vorschriften durchgeführt werden.

Veröffentlicht von

Loxone Electronics GmbH
Smart Home 1
4154 Kollerschlag
Austria
Tel: +43 7287 7070-0
loxone.com

Loxone UK Ltd.
The Forum
Station Road
Theale, RG7 4RA
United Kingdom