

Datasheet

Touch Tree Anthracite

Part No: 100222

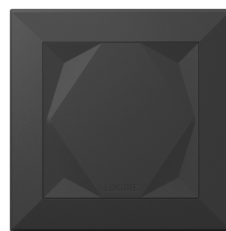

About the product

The Loxone Touch Tree has **five touch points** for operating the most important functions in a room. When a button is touched, a click is heard as **acoustic confirmation**. A sensor is integrated to measure **temperature and relative humidity**.

Electrical Specifications

Supply voltage	9 ... 28 VDC
Power consumption	typ. 0.115 W
Power loss	max. 115mW
Temperature	-20 ... 70°C / -4 ... 158°F
Touch points	5 touch points, capacitive touch detection
Click feedback	Yes
Temperature detection range	-40 ... 125°C / -40 ... 257°F; +/- 0.5°C / 0.9°F
Humidity detection range	0 ... 100% r.H. +/- 2%, (non condensing)
Recommended mounting height	135cm / 53.15"

Ambient Conditions

Humidity	max. 95% r.H. (non condensing)
----------	--------------------------------

Connections

Temperature resistance	-40 ... 105°C / -40 ... 221°F
------------------------	-------------------------------

Connection Terminals

Wire cross-section	0.25 ... 0.8 mm ² / AWG 23 ... 18
Stripping length	5 mm / 0.2"

Connection Diagram

Connection Diagram

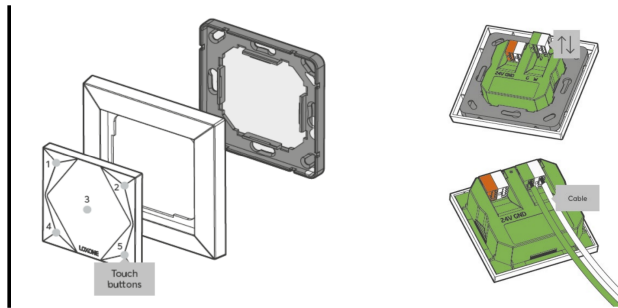

Product Characteristics

Colours
 Anthracite: RAL7016 - Part No. 100222
 White: RAL9003 - Part No. 100221

Finish
 Matte

Weight & Dimensions

Net weight
 65 g

Total weight
 85 g

Product dimensions
 80x80x10mm / 3.15x3.15x0.4" (LxWxH)

Product dimensions drawing

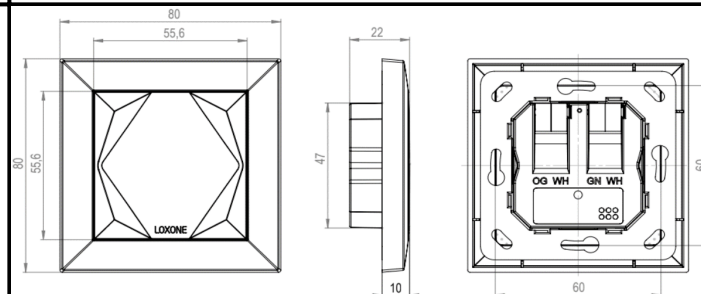

Pack size
 98x90x33mm / 3.86x3.54x1.30" (LxWxH)

Certifications & Standards

Safety class
 IP40

Certifications



Installation must be carried out by a qualified electrician in accordance with the relevant regulations.

Published by

LOXONE

Loxone Electronics GmbH
Smart Home 1
4154 Kollerschlag
Austria
Tel: +43 7287 7070-0
loxone.com

Loxone UK Ltd.
The Forum
Station Road
Theale, RG7 4RA
United Kingdom

Datenblatt

Touch Tree Anthrazit

Part No: 100222

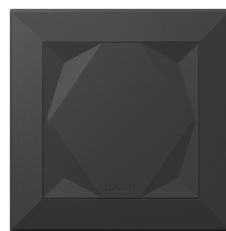

Über das Produkt

Der Loxone Touch Tree verfügt über **fünf Tastpunkte** zur Bedienung der wichtigsten Funktionen eines Raumes. Bei Berührung einer Taste erfolgt ein Klicken als **akustische Bestätigung**. Zur Messung von **Temperatur und relativer Luftfeuchte** ist ein Sensor integriert.

Elektrische Spezifikationen

Versorgungsspannung	9 ... 28 VDC
Leistungsaufnahme	typ. 0,115 W
Verlustleistung	max. 115mW
Temperatur	-20 ... 70°C / -4 ... 158°F
Tastpunkte	5 Tastpunkte, kapazitive Berührungserkennung
Klick Feedback	Ja
Messbereich Temperatursensor	-40 ... 125°C / -40 ... 257°F; +/- 0.5°C / 0.9°F
Messbereich Luftfeuchtigkeitssensor	0 ... 100% r.H. +/- 2%, (nicht kondensierend)
Empfohlene Montagehöhe	135cm / 53,15"

Umgebungsbedingungen

Luftfeuchtigkeit	max. 95% r.H. (nicht kondensierend)
------------------	-------------------------------------

Anschlüsse

Temperaturbeständigkeit	-40 ... 105°C / -40 ... 221°F
-------------------------	-------------------------------

Anschlussklemmen

Leiterquerschnitt	0,25 ... 0,8 mm ² / AWG 23 ... 18
Abisolierlänge	5 mm / 0,2"

Anschlussplan

Anschlussplan

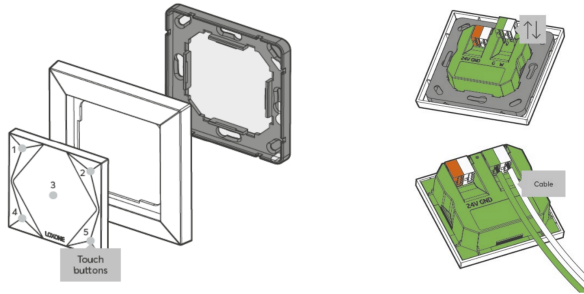

Produkteigenschaften

Farbe	Anthrazit: RAL7016 - Art. Nr. 100222 Weiß: RAL9003 - Art. Nr. 100221
Glanzgrad	Matt

Gewicht & Abmessungen

Nettogewicht	65 g
Bruttogewicht	85 g
Produktmaße	80x80x10mm / 3,15x3,15x0,4" (LxBxH)

Produktmaßzeichnung

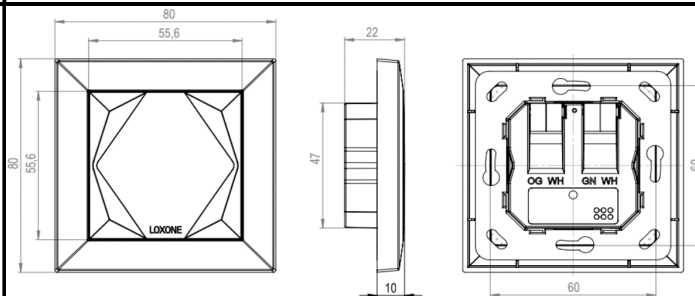

Packmaß	98x90x33mm / 3,86x3,54x1,30" (LxBxH)
---------	--------------------------------------

Zertifizierungen & Standards

Schutzklasse	IP40
Zertifizierungen	

LOXONE

Die Installation muss von einer qualifizierten Elektrofachkraft gemäß den einschlägigen Vorschriften durchgeführt werden.

Veröffentlicht von

Loxone Electronics GmbH
Smart Home 1
4154 Kollerschlag
Austria
Tel: +43 7287 7070-0
loxone.com

Loxone UK Ltd.
The Forum
Station Road
Theale, RG7 4RA
United Kingdom