

Datasheet

Install Speaker 10 Client

Part No: 610153



About the product

The Install Speaker 10 Client impresses with its excellent audio properties and its **numerous application possibilities**. It receives its audio signal from a **Master speaker** and can pass it on to other **Client speakers**. In this way, it forms a **flexible audio solution** that is scalable for any building size.

Features:

- Countless functions such as text-to-speech, doorbell, alarms or audio notifications
- Music streaming via Bluetooth (Master speaker required)
- Single-frame construction for a very compact design with minimal acoustically disturbing edges and a maximum membrane surface
- Coaxial system for extremely uniform and wide radiation behavior
- Up to 30m cable length between the clients
- Suitable for indoor and protected outdoor areas

Supply and Power

Supply voltage	18VDC ... 26VDC
Power consumption	0,05W (Standby) 35W (Peak)

Interfaces

Master-Client Interface (MCI)	up to 20 speaker clients per Master up to 30m wire length between clients up to 600m total length Wiring: Twisted pair, Line topology
-------------------------------	--

Audio Specifications

Speaker type	2-Way active speaker
Class-D Amplifier	35W nominal power 70W peak power
Frequency range	35 ... 23000Hz
Crossover frequency	1 600 Hz
SPL	108dB @ 1m max.
Woofer Ø	254 mm / 10"
Woofer membrane material	Altima (Aluminium-, Titanium-, Magnesium- composite)
Tweeter Ø	32 mm / 1.25"
Tweeter dome material	Titanium

Connection Terminals

Terminal type	24VDC: TFKC 2.5 Tree Turbo, MCI: DG220B
Wire cross-section	24VDC: 1 ... 2.5mm ² / AWG17... 12 Tree Turbo, MCI: 0.28 ... 0.8mm ² / AWG23 ... 18
Conductor type	24VDC: Stranded / Solid Tree Turbo, MCI: Solid
Stripping length	24VDC: 10mm / 0.39" Tree Turbo, MCI: 5 ... 6mm / 0.2 ... 0.24"
Temperature resistance	24VDC: -40 ... 70°C / -40 ... 158°F Tree Turbo, MCI: -40 ... 105°C / -40 ... 221°F
Connection type	24VDC: Push-in Tree Turbo, MCI: Push-in

Connection Diagram

Connection Diagram

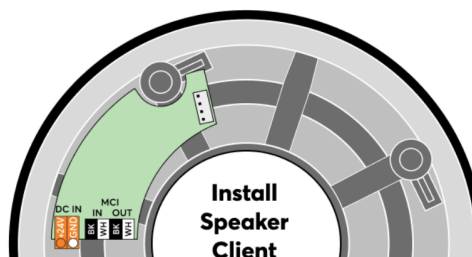

Product Characteristics

Colours	Speaker: Black, RAL9004 Front grille: White, RAL9003
Finish	Matte



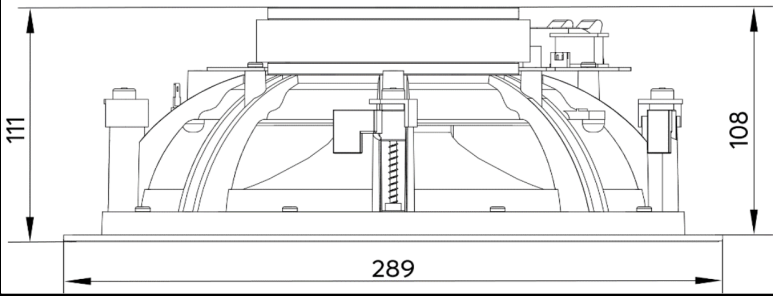

Weight & Dimensions

Net weight	2.85 kg
Total weight	3.45 kg
Hole cut out size	258 mm / 10.2" (Ø)
Installation depth	108 mm / 4.25"
Max. panel thickness	36 mm / 1.41"
Product dimensions	289 x 111 mm / 11.38 x 4.37" (Ø x D)

Product dimensions drawing	
----------------------------	---

Pack size	325 x 330 x 150 mm / 12.80 x 12.99 x 5.91" (L x W x H)
-----------	--

Certifications & Standards

Ingress protection	 
Degree of pollution	3
Certifications	 

Ambient Conditions

Humidity	max. 95 % r. h. (non-condensing)
----------	----------------------------------

Installation must be carried out by a qualified electrician in accordance with the relevant regulations.

Published by

Loxone Electronics GmbH
Smart Home 1
4154 Kollerschlag
Austria
Tel: +43 7287 7070-0
loxone.com

Loxone UK Ltd.
The Forum
Station Road
Theale, RG7 4RA
United Kingdom

Datenblatt

Install Speaker 10 Client

Part No: 610153



Über das Produkt

Der Install Speaker 10 Client überzeugt durch seine hervorragenden Audioeigenschaften und seine **zahlreichen Einsatzmöglichkeiten**. Er empfängt sein Audiosignal von einem **Master Speaker** und kann es an weitere **Client Speaker weitergeben**. Auf diese Weise bildet er eine **flexible Audiolösung**, die für jede Gebäudegröße skalierbar ist.

Features:

- Unzählige Funktionen wie Text-to-Speech, Türklingel, Alarmer oder Audio-Benachrichtigungen
- Musikstreaming über Bluetooth (Master Speaker erforderlich)
- Single-Frame Konstruktion für eine sehr kompakte Bauform bei minimalen akustisch störenden Kanten und einer maximalen Membranfläche
- Koaxialsystem für ein extrem gleichmäßiges und breites Abstrahlverhalten
- Bis zu 30m Kabellänge zwischen den Clients
- Geeignet für Innen und den geschützten Außenbereich

Versorgung und Leistung

Versorgungsspannung	18VDC ... 26VDC
Leistungsaufnahme	0,05W (Standby) 35W (Spitze)

Schnittstellen

Master-Client Interface (MCI)	bis zu 20 Speaker Clients pro Master bis zu 30m Kabellänge zwischen den Clients bis zu 600m Gesamtlänge Verkabelung: Twisted Pair, Linientopologie
-------------------------------	---

Audio-Spezifikationen

Lautsprecher Typ	2-Wege Aktiv-Lautsprecher
Class-D-Verstärker	35W Nennleistung 70W Spitzenleistung
Übertragungsbereich	35 ... 23000Hz
Übergangsfrequenz	1 600 Hz
SPL	108dB @ 1m max.
Tieftöner Ø	254 mm / 10"
Tieftöner-Membranmaterial	Altima (Aluminium-, Titan-, Magnesium- Verbundwerkstoff)
Hochtöner Ø	32 mm / 1,25"
Hochtöner-Kalottenmaterial	Titanium

Anschlussklemmen

Klemmentyp	24VDC: TFKC 2.5 Tree Turbo, MCI: DG220B
Leiterquerschnitt	24VDC: 1 ... 2,5mm ² / AWG17... 12 Tree Turbo, MCI: 0,28 ... 0,8mm ² / AWG23 ... 18
Leitertyp	24VDC: Flexibel / Starr Tree Turbo, MCI: Starr
Abisolierlänge	24VDC: 10mm / 0,39" Tree Turbo, MCI: 5 ... 6mm / 0,2 ... 0,24"
Temperaturbeständigkeit	24VDC: -40 ... 70°C / -40 ... 158°F Tree Turbo, MCI: -40 ... 105°C / -40 ... 221°F
Anschlussart	24VDC: Push-in Tree Turbo, MCI: Push-in

Anschlussplan

Anschlussplan

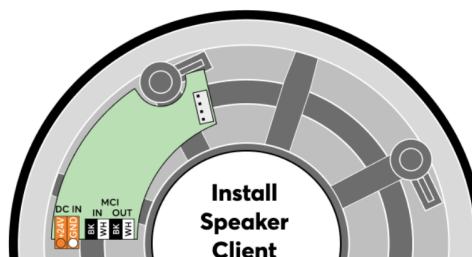



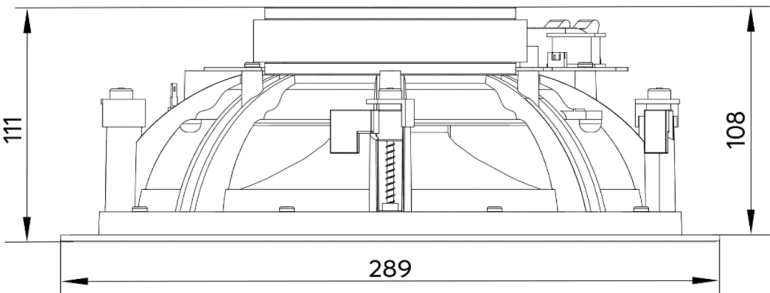

Produkteigenschaften

Farbe	Lautsprecher: Schwarz, RAL9004 Frontgitter: Weiß, RAL9003
Glanzgrad	Matt

Gewicht & Abmessungen

Nettogewicht	2,85 kg
Bruttogewicht	3,45 kg
Ausschnittgröße	258 mm / 10,2" (Ø)
Einbautiefe	108 mm / 4,25"
Max. Plattenstärke	36 mm / 1.41"
Produktmaße	289 x 111 mm / 11,38 x 4,37" (Ø x T)
Produktmaßzeichnung	
Packmaß	325 x 330 x 150 mm / 12,80 x 12,99 x 5,91" (L x B x H)

Zertifizierungen & Standards

Schutzart	 
Verschmutzungsgrad	3
Zertifizierungen	 

Umgebungsbedingungen

Luftfeuchtigkeit	max. 95 % r. F. (nicht kondensierend)
------------------	---------------------------------------

Die Installation muss von einer qualifizierten Elektrofachkraft gemäß den einschlägigen Vorschriften durchgeführt werden.

Veröffentlicht von

Loxone Electronics GmbH
Smart Home 1
4154 Kollerschlag
Austria
Tel: +43 7287 7070-0
loxone.com

Loxone UK Ltd.
The Forum
Station Road
Theale, RG7 4RA
United Kingdom